





Werkschrift



januari 2012







Op deze pagina vind je een overzicht van alle modellen. De stippen geven de moeilijkheidsgraad van het model aan. De modellen zijn genummerd. In volgorde van de nummers kun je in het werkschrift de beschrijvingen vinden. De paginacijfers verwijzen naar de foto's in het tijdschrift.

Jasje





				
15 JASJE ●●● maten 34-36-38-40-42-44-46 zie pag. 4, 77	16 JASJE ●●●● maten 34-36-38-40-42-44-46 zie pag. 6, 76, 80	17 JASJE ●●● maten 34-36-38-40-42-44-46 zie pag. 5, 76	18 JASJE ●●● maten 34-36-38-40-42-44-46 zie pag. 7, 81	19 JASJE ●●● maten 34-36-38-40-42-44-46 zie pag. 8

Jurk/tuniek

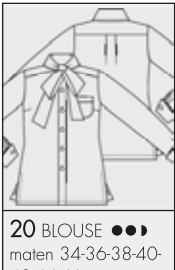

	
1 JURK ●●● maten 34-36-38-40-42-44-46 zie pag. 63	2 JURK ●●● maten 34-36-38-40-42-44-46 zie pag. 61, 78



						
3 JURK ●●● maten 34-36-38-40-42-44-46 zie pag. 63, 78	4 JURK ●●● maten 34-36-38-40-42-44-46 zie pag. 62	5 JURK ●●● maten 34-36-38-40-42-44-46 zie pag. 60	24 JURK ●●● maten 44-46-48-50-52-54-56 zie pag. 10	25 JURK ●●● maten 44-46-48-50-52-54-56 zie pag. 11	26 JURK ●●● maten 44-46-48-50-52-54-56 zie pag. 12	27 TUNIEK ●●● maten 44-46-48-50-52-54-56 zie pag. 11

Blouse/top

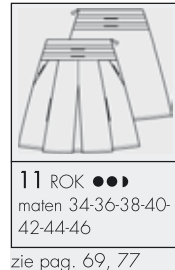

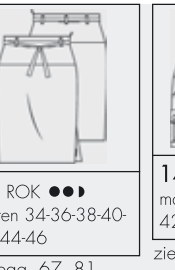
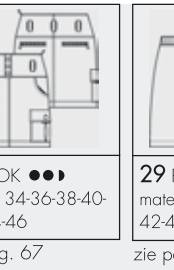

				
20 BLOUSE ●●● maten 34-36-38-40-42-44-46 zie pag. 71, 79	21 BLOUSE ●●● maten 34-36-38-40-42-44-46 zie pag. 71, 77, 80	22 BLOUSE ●●● maten 34-36-38-40-42-44-46 zie pag. 70	23 BLOUSE ●●● maten 34-36-38-40-42-44-46 zie pag. 72	28 TOP ●● maten 34-36-38-40-42-44-46 zie pag. 17 t/m 19

Rok

	
11 ROK ●●● maten 34-36-38-40-42-44-46 zie pag. 69, 77	12 ROK ●● maten 34-36-38-40-42-44-46 zie pag. 66, 80

		
13 ROK ●●● maten 34-36-38-40-42-44-46 zie pag. 67, 81	14 ROK ●●● maten 34-36-38-40-42-44-46 zie pag. 67	29 ROK ●● maten 34-36-38-40-42-44-46 zie pag. 17 t/m 19

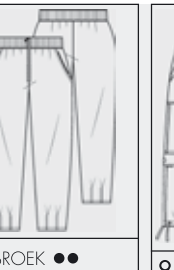
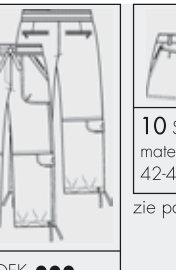
Broek/short

				
6 BROEK ●●● maten 34-36-38-40-42-44-46 zie pag. 21, 81	7 BROEK ●●● maten 34-36-38-40-42-44-46 zie pag. 21, 80	8 BROEK ●● maten 34-36-38-40-42-44-46 zie pag. 20, 76	9 BROEK ●●● maten 34-36-38-40-42-44-46 zie pag. 22, 77	10 SHORT ●●● maten 34-36-38-40-42-44-46 zie pag. 22, 76